

## Connector

# 11096503

## PEC ALU - D160/250

The PEC aluminium circular 90° branch connector makes a right-angle branch on an aluminium circular duct.



Piquage Equerre Circulaire en aluminium

### PRODUCT BENEFITS

- range compliant with gas CMEV requirements,
- suited to systems operating in saline atmospheres.

### Product description

The PEC aluminium circular 90° branch connector makes a right-angle branch on an aluminium circular duct.

### Fields of application

Multi-occupancy residential housing, New, Refurbishment, Non-residential buildings

### Installation

- when installing, pay special attention to pressures losses, noise and leaks that may be generated,
- easy assembly of interlocking accessories: ducts are female, accessories are male,
- final seal requires sealant and/or perforated strip,
- attached to duct using self-tapping screws (4 to 6 depending on diameter).

### Reference arguments

Application:

- Serves to add a 90° bend diameter 250 mm to circular ducting diameter 160 mm in a gas CMEV system

Description:

- Aluminium connector diameter 160/250 mm

### Main characteristics

- available in diameters from 125 to 500,
- aluminium 1050A-H18 (formerly A5) compliant with DTU 68.3 for gas CMEV,
- M0 fire certification.

### Dimensional data

References	Ø A (mm)	Ø B (mm)
11096503	250	160

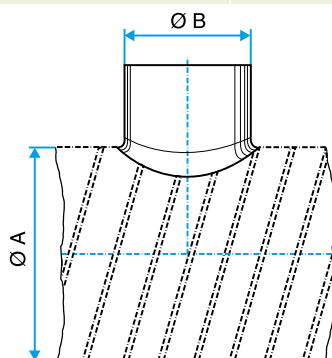

Dimensional drawing Circular 90° branch connector, aluminium

## Connector

**11096503**  
PEC ALU - D160/250

## Regulatory data

References	Fire protection rating
11096503	M0