

Connector

11096509

PEC ALU - D200/250

The PEC aluminium circular 90° branch connector makes a right-angle branch on an aluminium circular duct.



Piquage Equerre Circulaire en aluminium

PRODUCT BENEFITS

- range compliant with gas CMEV requirements,
- suited to systems operating in saline atmospheres.

Product description

The PEC aluminium circular 90° branch connector makes a right-angle branch on an aluminium circular duct.

Fields of application

Multi-occupancy residential housing, New, Refurbishment, Non-residential buildings

Installation

- when installing, pay special attention to pressures losses, noise and leaks that may be generated,
- easy assembly of interlocking accessories: ducts are female, accessories are male,
- final seal requires sealant and/or perforated strip,
- attached to duct using self-tapping screws (4 to 6 depending on diameter).

Reference arguments

Application:

- Serves to add a 90° bend diameter 250 mm to circular ducting diameter 200 mm in a gas CMEV system

Description:

- Aluminium connector diameter 200/250 mm

Main characteristics

- available in diameters from 125 to 500,
- aluminium 1050A-H18 (formerly A5) compliant with DTU 68.3 for gas CMEV,
- M0 fire certification.

Dimensional data

References	Ø A (mm)	Ø B (mm)
11096509	250	200

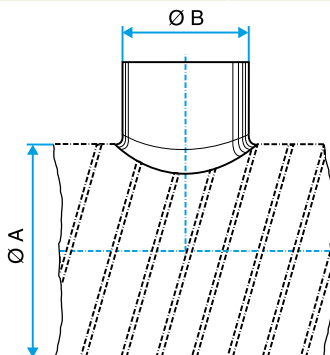

Dimensional drawing Circular 90° branch connector, aluminium

Connector

11096509
PEC ALU - D200/250

Regulatory data

References	Fire protection rating
11096509	M0