

Connector**11098270****PEC GALVA Branch piece+seal - Ø 200/200 mm**

The PEC sealed circular 90° branch connector makes a right-angle branch on a galvanised circular duct.

**PRODUCT BENEFITS**

- easy and quick to install,
- aesthetic ducting.

Product description

The PEC sealed circular 90° branch connector makes a right-angle branch on a galvanised circular duct. The PEC sealed circular 90° branch connector is for use on horizontal branches specific to commercial systems. It is not recommended for use on residential type risers (use factory-fitted CRE storey elements).

Fields of application

Multi-occupancy residential housing, New, Refurbishment, Non-residential buildings

Installation

- when installing, pay special attention to pressures losses, noise and leaks that may be generated
- prioritise the use of factory-produced sealed T-pieces,
- to slot in or remove an accessory, rotate it slightly in the duct,
- as an airtight junction is automatically provided by the ALDES seal, no need to use sealant or adhesive tape,
- for vertical installations especially, the use of self-tapping screws remains recommended,
- time savings in relation to ducting with standard accessories is in the range of 20 % (at least 15 to 30 seconds saved per junction for diameters 125 to 315, or at least 30 to 60 seconds saved for each accessory in these diameters),
- ALDES sealed accessories are specially designed to ensure easy connection / disconnection. The ALDES range offers class C airtight performance and low connection torque.

Reference arguments

Application:

- Serves to add a 90° sealed bend diameter 200 mm to circular ducting diameter 200 mm.

Description:

- Sealed connector galvanised steel diameter 200/200 mm

Main characteristics

- available in diameters from 125 to 315,
- galvanised steel as per EN 10346 ensuring uniformity of coating,
- all junctions are crimped,
- temperature range: - 30°C à + 100°C,
- resistant to ageing (• 30 years), UV and ozone,
- MO fire certification,
- not advised for class C airtight performance.

General data

Variants	Main material
11098270	Galvanised steel

Connector

11098270

PEC GALVA Branch piece+seal - Ø 200/200 mm

Dimensional data

Variants	Ø A (mm)	Ø B (mm)
11098270	200	200

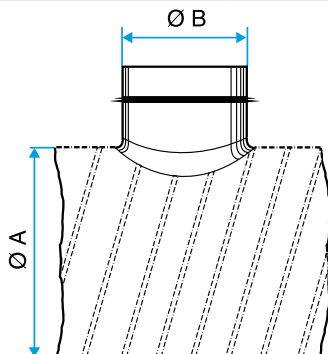

Regulatory data

Variants	Fire protection rating
11098270	M0