

Connector

11097255

POC ANGLE GALVA - D250/500

The PEC circular branch connector makes a 45° angle branch on a galvanised circular duct.



Piquage Oblique Circulaire 45°

Product description

The PEC circular branch connector makes a 45° angle branch on a galvanised circular duct.

Fields of application

Multi-occupancy residential housing, New, Refurbishment, Non-residential buildings

Installation

- when installing, pay special attention to pressures losses, noise and leaks that may be generated,
- easy assembly of interlocking accessories: ducts are female, accessories are male,
- final seal requires sealant and/or perforated strip,
- attached to duct using self-tapping screws (4 to 6 depending on diameter).

Reference arguments

Application:

- Serves to add a 45° bend diameter 500 mm to circular ducting diameter 250 mm.

Description:

- Angled connector galvanised steel diameter 250/500 mm

Main characteristics

- available in diameters from 80 to 900,
- galvanised steel as per EN 10346 ensuring uniformity of coating,
- M0 fire certification.

Dimensional data

References	Ø A (mm)	Ø B (mm)
11097255	500	250

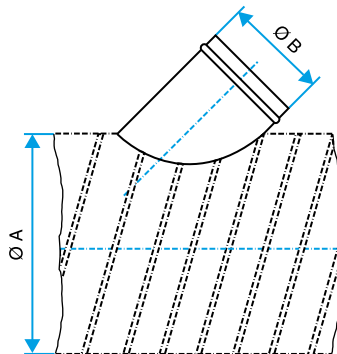

Dimensional drawing Circular 45° angled branch connector

Connector

11097255
POC ANGLE GALVA - D250/500

Regulatory data

References	Fire protection rating
11097255	M0