

Connector

11097335

POC ANGLE GALVA - D710/800

The PEC circular branch connector makes a 45° angle branch on a galvanised circular duct.



Piquage Oblique Circulaire 45°

Product description

The PEC circular branch connector makes a 45° angle branch on a galvanised circular duct.

Fields of application

Multi-occupancy residential housing, New, Refurbishment, Non-residential buildings

Installation

- when installing, pay special attention to pressures losses, noise and leaks that may be generated,
- easy assembly of interlocking accessories: ducts are female, accessories are male,
- final seal requires sealant and/or perforated strip,
- attached to duct using self-tapping screws (4 to 6 depending on diameter).

Reference arguments

Application:

- Serves to add a 45° bend diameter 800 mm to circular ducting diameter 710 mm.

Description:

- Angled connector galvanised steel diameter 710/800 mm

Main characteristics

- available in diameters from 80 to 900,
- galvanised steel as per EN 10346 ensuring uniformity of coating,
- M0 fire certification.

Dimensional data

| References | Ø A (mm) | Ø B (mm) |
|------------|----------|----------|
| 11097335 | 800 | 710 |

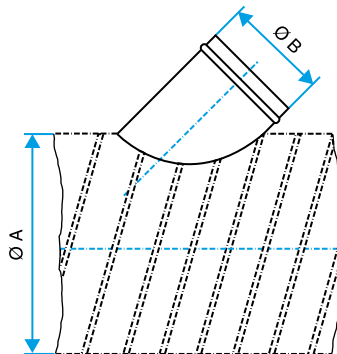

Dimensional drawing Circular 45° angled branch connector

Connector

11097335

POC ANGLE GALVA - D710/800

Regulatory data

| References | Fire protection rating |
|------------|------------------------|
| 11097335 | M0 |