

# 11057535

## ParkONE car park smoke and heat exhaust unit DAH HS 20-25A LS 9-12A

The residential car park smoke and heat exhaust units control the 2-speed axial fans for ventilation, smoke and heat exhaust.



ParkONE car park smoke and heat exhaust system for multi-

### PRODUCT BENEFITS

- Programmable timer to meet ventilation needs while saving energy
- 3-position switch used to control the box: stop; forced smoke and heat exhaust and high speed; comfort

### Product description

Thanks to its built-in clock, the residential car park smoke and heat exhaust system can program the fan (Off/Smoke and heat exhaust/Comfort) in anticipation of vehicle traffic in the car park. This system is especially suited to parking areas for multi-occupancy residential buildings. It controls the activation of manual smoke and heat exhaust and shutdown of smoke exhaust when instructed by the Fire service.

### Fields of application

Multi-occupancy residential housing, New, Refurbishment, Non-residential buildings

### Installation

- Smoke and heat exhaust unit attached to wall.

### Reference arguments

- IP55 key-operated plastic box.
- Dimensions: length x width x depth = 375 x 375 x 200 mm.
- Backed-up weekly programmable timer.
- Motor protected at high and low speed by thermal-magnetic circuit breakers. Current intensity selected according to motors used.
- Range for 2-speed motor with Dahlander windings. 3-phase 400 V
- Input/output terminals for manual smoke control trip devices, current break (opening dry contact).
- Possible to connect key-operated fire brigade shut-off (opening dry contact).
- Manual and plans available from your local branch.

### Main characteristics

- IP55 key-operated plastic box,
- dimensions for models 4 to 32A: lxhxd= 375 x 375 x 180 mm,
- dimensions for models 40 to 57A: lxhxd= 375 x 500 x 230 mm,
- dimensions for 2 fan models : lxhxd= 375 x 750 x 230 mm,
- backed-up weekly programmable timer,
- motor protected at high and low speed with thermal-magnetic circuit breakers, current intensity selected according to motors used,
- range for 2-speed motor with Dahlander windings, 3-phase 400V
- input/output terminals for manual triggering devices current break (opening dry contact)
- possible to connect key-operated fire brigade shut-off (opening dry contact)
- manual and plans available from your local branch.

### Accessories

Désignations	References
Fire service shutdown box NO + NC residential parking	11057251
Manual trip device	11044121

## 11057535 ParkONE car park unit DAH HS 20-25A LS 9-12A

### Dimensional data

References	H (mm)	L (mm)	P (mm)
11057535	375	375	180

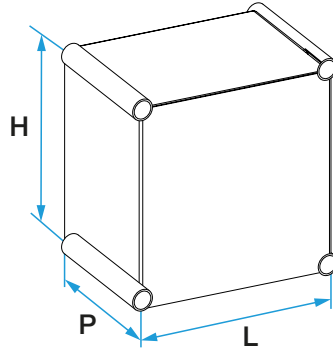

### Principe de fonctionnement

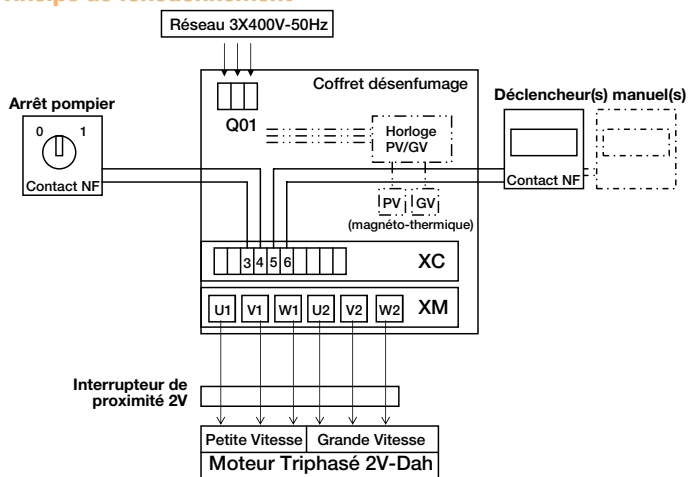

Principe de câblage