

Airflow control**11098555****RCE GALVA Branch piece+seal - Ø 250/200 mm**

The sealed RCE concentric conical reducer is used to join two galvanised ducts of different diameters together while delivering class C airtight performance.

**PRODUCT BENEFITS**

- easy and quick to install,
- class C airtight performance,
- aesthetic ducting.

Product description

The sealed RCE offset conical reducer is used to join two galvanised ducts of different diameters together in commercial or multi-occupancy residential systems, while delivering class C airtight performance. Furthermore, the offset conical reducer maintains a constant system height.

Fields of application

Multi-occupancy residential housing, New, Refurbishment, Non-residential buildings

Installation

- to slot in or remove an accessory, rotate it slightly in the duct,
- as an airtight seal is automatically provided by the ALDES seal, no need to use sealant or adhesive tape,
- for vertical installations especially, the use of self-tapping screws remains recommended,
- time savings in relation to ducting with standard accessories is in the range of 20 % (at least 15 to 30 seconds saved per junction for diameters 125 to 315, or at least 30 to 60 seconds saved for each accessory in these diameters),
- ALDES sealed accessories are specially designed to ensure easy connection / disconnection. The ALDES range offers class C airtight performance and low connection torque.

Reference arguments

Application:

- Sealed connection between a 250 mm circular duct to offset 200 mm circular duct in a non-residential or multi-occupancy residential system
- The offset reducer maintains the ducting at the same height

Description:

- Sealed offset conical reducer galvanised steel diameter 250/200 mm

Main characteristics

- available in diameters from 125 to 560,
- galvanised steel as per EN 10346 ensuring uniformity of coating,
- temperature range: - 30°C à + 100°C,
- resistant to ageing (• 30 years), UV and ozone,
- M0 fire certification,
- class C airtight performance as per standard NF EN 12237.

General data

Variants	Main material
11098555	Galvanised steel

Airflow control

11098555

RCE GALVA Branch piece+seal - Ø 250/200 mm

Dimensional data

Variants	Ø A (mm)	Ø B (mm)
11098555	250	200

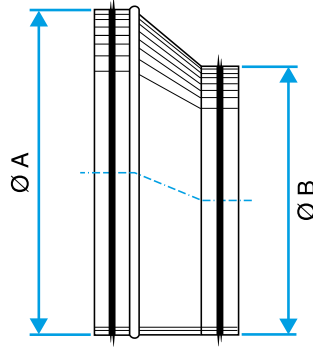

Regulatory data

Variants	Fire protection rating
11098555	M0