

## Connector

# 11066355

## RCO GALVA - 545x165 / 425x130

The RCO oblong concentric reducer joins two galvanised ducts of different diameters together.



Oblong Concentric Reducer

### PRODUCT BENEFITS

- small size for high airflow,
- good airtight performance and controlled pressure losses,
- easy to install and maintain (no inaccessible corners).

### Product description

The RCO oblong concentric reducer joins two galvanised ducts of different diameters together.

### Fields of application

Multi-occupancy residential housing, New, Refurbishment, Non-residential buildings

### Installation

- easy assembly of interlocking accessories: ducts are female, accessories are male,
- Final seal requires sealant and/or perforated strip,
- attached to duct using self-tapping screws (4 to 6 depending on diameter).

### Reference arguments

Application:

- Oblong accessories for installation of ventilation systems in confined spaces (suspended ceiling, horizontal side flues conveying high airflow, etc.)
- Oblong concentric reducer used to connect two oblong ducts of different sizes

Description:

- RCO oblong-oblong concentric reducer, galvanised steel
- Length 545 mm x height 165 mm - Length 425 mm x height 130 mm

### Main characteristics

- standard dimensions (20 oblong sections),
- galvanised steel as per EN 10346 ensuring uniformity of coating,
- MO fire certification.

### Dimensional data

References	H (mm)	L (mm)
11066355	165	545



Dimensional diagram Oblong Concentric Reducer

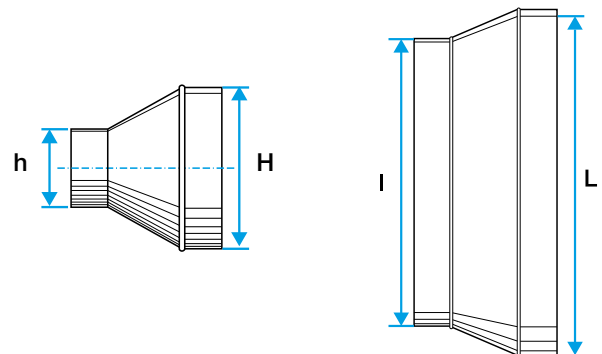

Dimensional diagram Oblong Concentric Reducer

### Connector

# 11066355

RCO GALVA - 545x165 / 425x130

### Regulatory data

References	Fire protection rating
11066355	M0