

Connector

11064109

RCO GALVA - 880x215 / 700x165

The RCO oblong concentric reducer joins two galvanised ducts of different diameters together.



Oblong Concentric Reducer

PRODUCT BENEFITS

- small size for high airflow,
- good airtight performance and controlled pressure losses,
- easy to install and maintain (no inaccessible corners).

Product description

The RCO oblong concentric reducer joins two galvanised ducts of different diameters together.

Fields of application

Multi-occupancy residential housing, New, Refurbishment, Non-residential buildings

Installation

- easy assembly of interlocking accessories: ducts are female, accessories are male,
- Final seal requires sealant and/or perforated strip,
- attached to duct using self-tapping screws (4 to 6 depending on diameter).

Reference arguments

Application:

- Oblong accessories for installation of ventilation systems in confined spaces (suspended ceiling, horizontal side flues conveying high airflow, etc.)
- Oblong concentric reducer used to connect two oblong ducts of different sizes

Description:

- RCO oblong-oblong concentric reducer, galvanised steel
- Length 880 mm x height 215 mm - Length 700 mm x height 165 mm

Main characteristics

- standard dimensions (20 oblong sections),
- galvanised steel as per EN 10346 ensuring uniformity of coating,
- MO fire certification.

Dimensional data

References	H (mm)	L (mm)
11064109	215	880

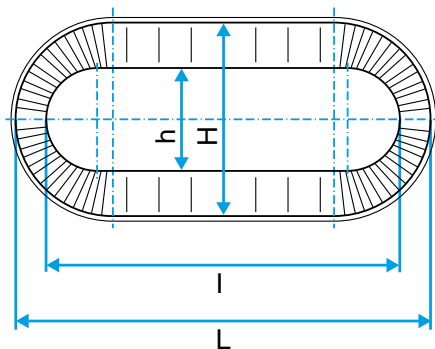

Dimensional diagram Oblong Concentric Reducer

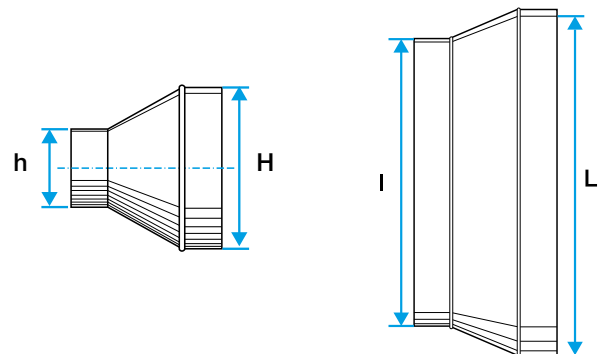

Dimensional diagram Oblong Concentric Reducer

Connector

11064109

RCO GALVA - 880x215 / 700x165

Regulatory data

References	Fire protection rating
11064109	M0