

Connector

11066442

RCOC GALVA - 325x130 - D160

The RCOC oblong / circular concentric reducer connects an oblong duct to a circular duct.



Oblong Cylindrical Concentric Reducer

PRODUCT BENEFITS

- small size for high airflow,
- good airtight performance and controlled pressure losses,
- easy to install and maintain (no inaccessible corners).

Product description

The RCOC oblong / circular concentric reducer connects an oblong duct to a circular duct.

Fields of application

Multi-occupancy residential housing, New, Refurbishment, Non-residential buildings

Installation

- easy assembly of interlocking accessories: ducts are female, accessories are male,
- Final seal requires sealant and/or perforated strip,
- attached to duct using self-tapping screws (4 to 6 depending on diameter).

Reference arguments

Application:

- Oblong accessories for installation of ventilation systems in confined spaces (suspended ceiling, horizontal side flues conveying high airflow, etc.)
- Cylindrical oblong concentric reduction used to connected oblong ducting diameter 325 x 130 mm and circular ducting diameter 160 mm

Description:

- RCOC cylindrical oblong concentric reducer, galvanised steel
- Length 325 mm x height 130 mm - diameter 160 mm

Main characteristics

- standard dimensions (20 oblong sections),
- galvanised steel as per EN 10346 ensuring uniformity of coating,
- MO fire certification.

Dimensional data

References	H (mm)	L (mm)	Ø (mm)
11066442	130	325	160

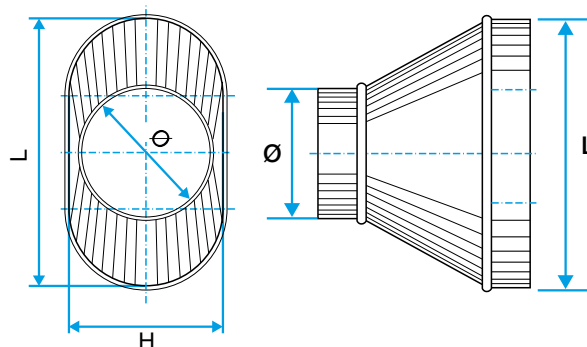

Dimensional drawing Oblong Cylindrical Concentric Reducer

Connector

11066442

RCOC GALVA - 325x130 - D160

Regulatory data

References	Fire protection rating
11066442	M0