

Connector**11063846****RCOC GALVA - 350x100 - D250**

The RCOC oblong / circular concentric reducer connects an oblong duct to a circular duct.

**PRODUCT BENEFITS**

- small size for high airflow,
- good airtight performance and controlled pressure losses,
- easy to install and maintain (no inaccessible corners).

Produktbeskrivelse

The RCOC oblong / circular concentric reducer connects an oblong duct to a circular duct.

Fields of application

Multi-occupancy residential housing, New, Refurbishment, Non-residential buildings

Installation

- easy assembly of interlocking accessories: ducts are female, accessories are male,
- Final seal requires sealant and/or perforated strip,
- attached to duct using self-tapping screws (4 to 6 depending on diameter).

Reference arguments

Application:

- Oblong accessories for installation of ventilation systems in confined spaces (suspended ceiling, horizontal side flues conveying high airflow, etc.)
- Concentric reducer used to connect oblong ducting to circular ducting

Description:

- RCOC cylindrical oblong concentric reducer, galvanised steel
- Length 350 mm and height 100 mm - Diameter 250 mm

Main characteristics

- standard dimensions (20 oblong sections),
- galvanised steel as per EN 10346 ensuring uniformity of coating,
- M0 fire certification.

General data

Variants	Main material
11063846	Galvanised steel

Connector

11063846

RCOC GALVA - 350x100 - D250

Dimensional data

Variants	H (mm)	L (mm)	Ø (mm)	Ø B (mm)
11063846	100	350	250	250

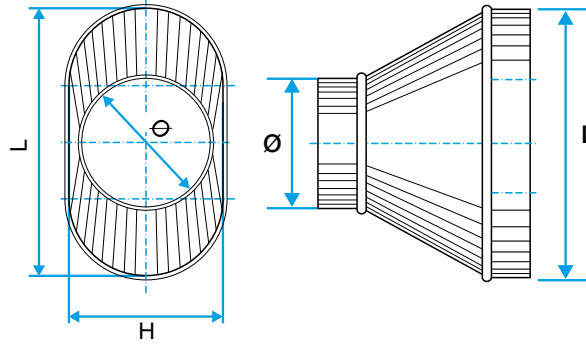

Regulatory data

Variants	Fire protection rating
11063846	M0