

## Connector

# 11063853

## RCOC GALVA - 475x165 - D200

The RCOC oblong / circular concentric reducer connects an oblong duct to a circular duct.



### PRODUCT BENEFITS

- small size for high airflow,
- good airtight performance and controlled pressure losses,
- easy to install and maintain (no inaccessible corners).

### Produktbeskrivelse

The RCOC oblong / circular concentric reducer connects an oblong duct to a circular duct.

### Fields of application

Multi-occupancy residential housing, New, Refurbishment, Non-residential buildings

### Installation

- easy assembly of interlocking accessories: ducts are female, accessories are male,
- Final seal requires sealant and/or perforated strip,
- attached to duct using self-tapping screws (4 to 6 depending on diameter).

### Reference arguments

Application:

- Oblong accessories for installation of ventilation systems in confined spaces (suspended ceiling, horizontal side flues conveying high airflow, etc.)
- Concentric reducer used to connect oblong ducting to circular ducting

Description:

- RCOC cylindrical oblong concentric reducer, galvanised steel
- Length 475 mm and height 165 mm - Diameter 200 mm

### Main characteristics

- standard dimensions (20 oblong sections),
- galvanised steel as per EN 10346 ensuring uniformity of coating,
- M0 fire certification.

### General data

Variants	Main material
11063853	Galvanised steel

Connector

## 11063853

RCOC GALVA - 475x165 - D200

Dimensional data

Variants	H (mm)	L (mm)	Ø (mm)	Ø B (mm)
11063853	165	475	200	200

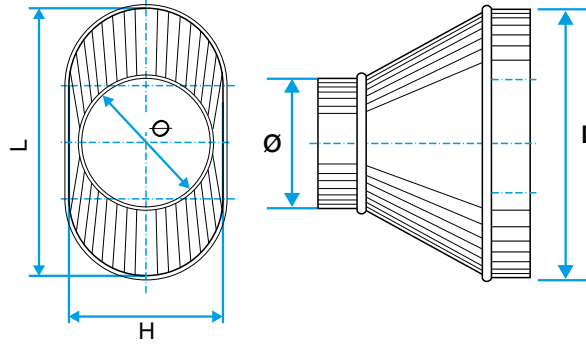

Regulatory data

Variants	Fire protection rating
11063853	M0