

**Connector****11066451**  
**RCOC GALVA - 490X130 - D315**

The RCOC oblong / circular concentric reducer connects an oblong duct to a circular duct.

**PRODUCT BENEFITS**

- small size for high airflow,
- good airtight performance and controlled pressure losses,
- easy to install and maintain (no inaccessible corners).

**Produktbeskrivelse**

The RCOC oblong / circular concentric reducer connects an oblong duct to a circular duct.

**Fields of application**

Multi-occupancy residential housing, New, Refurbishment, Non-residential buildings

**Installation**

- easy assembly of interlocking accessories: ducts are female, accessories are male,
- Final seal requires sealant and/or perforated strip,
- attached to duct using self-tapping screws (4 to 6 depending on diameter).

**Reference arguments**

Application:

- Oblong accessories for installation of ventilation systems in confined spaces (suspended ceiling, horizontal side flues conveying high airflow, etc.)
- Cylindrical oblong concentric reduction used to connected oblong ducting diameter 490 x 130 mm and circular ducting diameter 315 mm

Description:

- RCOC cylindrical oblong concentric reducer, galvanised steel
- Length 490 mm x height 130 mm - diameter 315 mm

**Main characteristics**

- standard dimensions (20 oblong sections),
- galvanised steel as per EN 10346 ensuring uniformity of coating,
- M0 fire certification.

**General data**

Variants	Main material
11066451	Galvanised steel

Connector

## 11066451

RCOC GALVA - 490X130 - D315

Dimensional data

Variants	H (mm)	L (mm)	Ø (mm)	Ø B (mm)
11066451	130	490	315	315

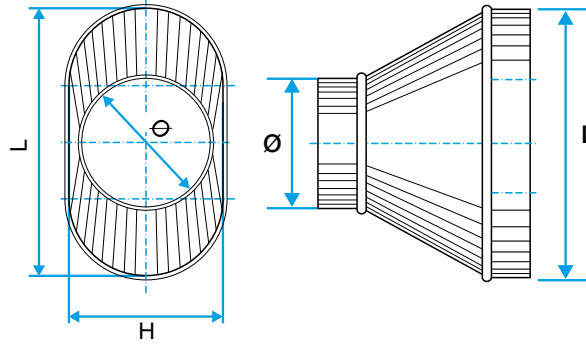

Regulatory data

Variants	Fire protection rating
11066451	M0