

Connector

11063868

RCOC GALVA - 675x215 - D450

The RCOC oblong / circular concentric reducer connects an oblong duct to a circular duct.



PRODUCT BENEFITS

- small size for high airflow,
- good airtight performance and controlled pressure losses,
- easy to install and maintain (no inaccessible corners).

Produktbeskrivelse

The RCOC oblong / circular concentric reducer connects an oblong duct to a circular duct.

Fields of application

Multi-occupancy residential housing, New, Refurbishment, Non-residential buildings

Installation

- easy assembly of interlocking accessories: ducts are female, accessories are male,
- Final seal requires sealant and/or perforated strip,
- attached to duct using self-tapping screws (4 to 6 depending on diameter).

Reference arguments

Application:

- Oblong accessories for installation of ventilation systems in confined spaces (suspended ceiling, horizontal side flues conveying high airflow, etc.)
- Concentric reducer used to connect oblong ducting to circular ducting

Description:

- RCOC cylindrical oblong concentric reducer, galvanised steel
- Length 675 mm and height 215 mm - Diameter 450 mm

Main characteristics

- standard dimensions (20 oblong sections),
- galvanised steel as per EN 10346 ensuring uniformity of coating,
- M0 fire certification.

General data

Variants	Main material
11063868	Galvanised steel

Connector

11063868

RCOC GALVA - 675x215 - D450

Dimensional data

Variants	H (mm)	L (mm)	Ø (mm)	Ø B (mm)
11063868	215	675	450	450

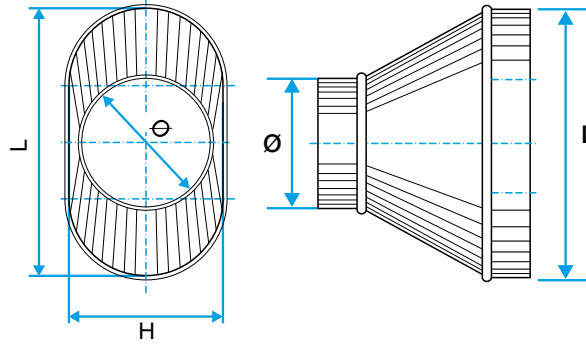

Regulatory data

Variants	Fire protection rating
11063868	M0