

## Connector

# 11063859

## RCOC GALVA - 700x165 - D315

The RCOC oblong / circular concentric reducer connects an oblong duct to a circular duct.



Oblong Cylindrical Concentric Reducer

### PRODUCT BENEFITS

- small size for high airflow,
- good airtight performance and controlled pressure losses,
- easy to install and maintain (no inaccessible corners).

### Product description

The RCOC oblong / circular concentric reducer connects an oblong duct to a circular duct.

### Fields of application

Multi-occupancy residential housing, New, Refurbishment, Non-residential buildings

### Installation

- easy assembly of interlocking accessories: ducts are female, accessories are male,
- Final seal requires sealant and/or perforated strip,
- attached to duct using self-tapping screws (4 to 6 depending on diameter).

### Reference arguments

Application:

- Oblong accessories for installation of ventilation systems in confined spaces (suspended ceiling, horizontal side flues conveying high airflow, etc.)
- Concentric reducer used to connect oblong ducting to circular ducting

Description:

- RCOC cylindrical oblong concentric reducer, galvanised steel
- Length 700 mm and height 165 mm - Diameter 315 mm

### Main characteristics

- standard dimensions (20 oblong sections),
- galvanised steel as per EN 10346 ensuring uniformity of coating,
- MO fire certification.

### Dimensional data

References	H (mm)	L (mm)	Ø (mm)
11063859	165	700	315

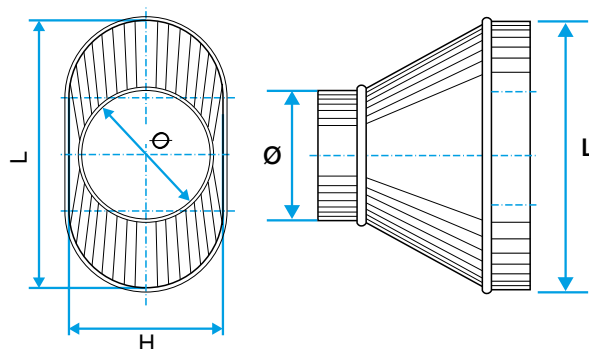

Dimensional drawing Oblong Cylindrical Concentric Reducer

### Connector

# 11063859

## RCOC GALVA - 700x165 - D315

### Regulatory data

References	Fire protection rating
11063859	M0