

Connector

11063903

RCOC GALVA - 895x415 - D630

The RCOC oblong / circular concentric reducer connects an oblong duct to a circular duct.



PRODUCT BENEFITS

- small size for high airflow,
- good airtight performance and controlled pressure losses,
- easy to install and maintain (no inaccessible corners).

Product description

The RCOC oblong / circular concentric reducer connects an oblong duct to a circular duct.

Fields of application

Multi-occupancy residential housing, New, Refurbishment, Non-residential buildings

Installation

- easy assembly of interlocking accessories: ducts are female, accessories are male,
- Final seal requires sealant and/or perforated strip,
- attached to duct using self-tapping screws (4 to 6 depending on diameter).

Reference arguments

Application:

- Oblong accessories for installation of ventilation systems in confined spaces (suspended ceiling, horizontal side flues conveying high airflow, etc.)
- Concentric reducer used to connect oblong ducting to circular ducting

Description:

- RCOC cylindrical oblong concentric reducer, galvanised steel
- Length 895 mm and height 415 mm - Diameter 630 mm

Main characteristics

- standard dimensions (20 oblong sections),
- galvanised steel as per EN 10346 ensuring uniformity of coating,
- MO fire certification.

Dimensional data

Variants	H (mm)	L (mm)	Ø (mm)
11063903	415	895	630

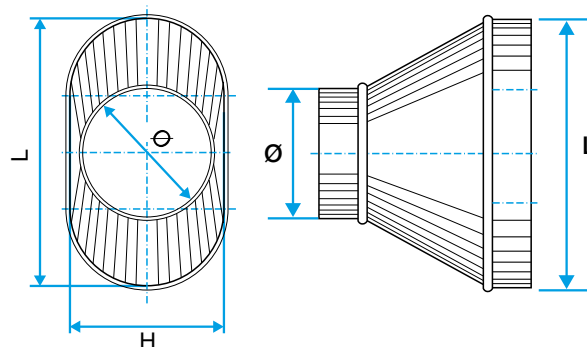

Connector

11063903

RCOC GALVA - 895x415 - D630

Regulatory data

Variants	Fire protection rating
11063903	M0