

Connector

11063056

RFO GALVA - 950x320

The RFO oblong female connector connects two galvanised oblong accessories together.



Raccord Femelle Oblong

PRODUCT BENEFITS

- small size for high airflow,
- good airtight performance and controlled pressure losses,
- easy to install and maintain (no inaccessible corners).

Product description

The RFO oblong female connector connects two galvanised oblong accessories together.

Fields of application

Multi-occupancy residential housing, New, Refurbishment, Non-residential buildings

Installation

- easy assembly of interlocking accessories: ducts are female, accessories are male,
- Final seal requires sealant and/or perforated strip,
- attached to duct using self-tapping screws (4 to 6 depending on diameter).

Reference arguments

Application:

- Oblong accessories for installation of ventilation systems in confined spaces (suspended ceiling, horizontal side flues conveying high airflow, etc.)
- Connection between two oblong accessories of same dimensions

Description:

- Oblong female connector made of galvanised steel.
- Length 950 mm and height 320 mm.

Main characteristics

- standard dimensions (20 oblong sections),
- galvanised steel as per EN 10346 ensuring uniformity of coating,
- MO fire certification.

Dimensional data

References	H (mm)	L (mm)
11063056	320	950

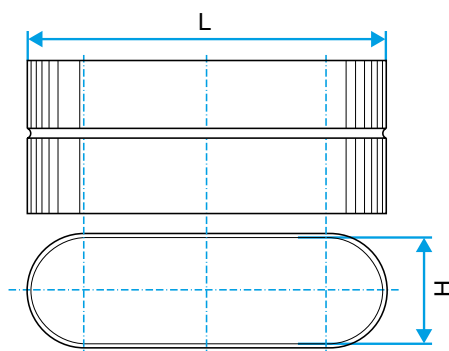

Dimensional drawing Oblong Female Connector

Connector

11063056
RFO GALVA - 950x320

Regulatory data

References	Fire protection rating
11063056	M0