

**Balancing damper****11095811**  
**RG ALU - D160**

The aluminium balancing damper is used to adjust the pressure in aluminium ducting branches in commercial or multi-occupancy residential buildings.



Registre d'Equilibrage en aluminium

**PRODUCT BENEFITS**

- range compliant with gas CMEV requirements,
- suited to systems operating in saline atmospheres.

**Product description**

The aluminium balancing damper is used to adjust the pressure in aluminium ducting branches in commercial or multi-occupancy residential buildings. The RGP aluminium balancing damper enables finer pressure adjustment than a standard damper, as it avoids closing off a duct branch fully (especially in gas CMEV systems).

**Fields of application**

Multi-occupancy residential housing, New, Refurbishment, Non-residential buildings

**Installation**

- easy assembly of interlocking accessories: ducts are female, accessories are male,
- Final seal requires sealant and/or perforated strip,
- attached to duct using self-tapping screws (4 to 6 depending on diameter).

**Reference arguments**

Application:

- Serves to balance airflow across all branches of a multi-occupancy residential gas CMEV system

Description:

- Aluminium damper diameter 160 mm
- Manual control
- Screw-locked plastic handle, M1 class Lexan shafts

**Main characteristics**

- available in diameters from 125 to 315,
- aluminium 1050A-H18 (formerly A5) compliant with DTU 68.3 for gas CMEV,
- screw-locked plastic handle, M1 certified Lexan shafts,
- RGP: perforated disc with 40% air passage, Ø 5 holes,
- maximum operating temperature: + 120°C,
- M0 fire certification.

## Balancing damper

# 11095811

RG ALU - D160

## Dimensional data

References	Ø (mm)
11095811	160

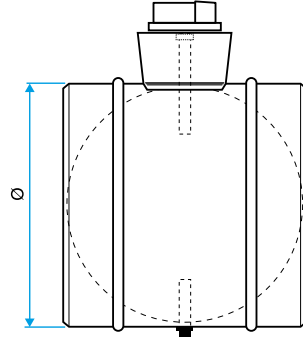

Encombrement Registres RG / RGP Alu