

Damper

11055118

RGE Ø450 Manual and Motorised with kit

The RGE damper uses a motor or manual operation to balance and isolate a circular ducting system, while ensuring a very low leak rate.



PRODUCT BENEFITS

- class C airtight performance as per EN 1751,
- manual or motorised operation using plate kit.

Principles of operation

The flap of the RGE manual damper is opened and closed by rotating a handle or using a motor after a motor plate is installed. If it is closed, the airtight seal is formed by the moulded seal on the disc.

Product description

The RGE damper balances airflow and isolates a circular ducting system. It features a sealed disc to minimise air leaks between upstream and of the damper in the closed position and double-lip airtight seals on each junction to minimise leaks with the rest of the system. Its top jumper enables overlaid insulation without covering the lockable handle.

Fields of application

Non-residential buildings

Installation

- installed in circular ducts.

Reference arguments

- Damper air tightness provided by jointed disk (overmoulding on disk providing good long-term resistance).
- Double-lip airtight seal on each junction.
- RGE: screw-locked adjustment handle. Zamak shafts.
- Upper jumper provides overlaid insulation without covering handle.
- To motorise RGE dampers beyond 355 mm: order the universal adapter plate (11055122) separately to enable installation of any motor.
- Motor power: 2 N/m for RGE Ø 125 to 200, 4-5 N/m for RGE Ø 250 to 500.
- Beyond Ø 500 mm, for reasons of mechanical resistance, use a CRGE volume control damper with connecting plates of the same Ø as the ducting.

Main characteristics

- galvanised steel,
- airtight performance upstream/downstream of disc: class 4 as per EN 1751,
- class C product airtight performance as per EN 12237,
- motor plate ordered separately,
- motor ordered separately: 4-5 N.m for RGE Ø 355 to 450 and 10 N.m for RGE Ø 500 mm,
- temperature range: 0 to 120°C.

Accessories

Description	Variants
MOTOR PLATE KIT FOR DIAMETERS 355 to 500 mm	11055122
LM MOTOR 24A ON/OFF	11055042
LM MOTOR 230A ON/OFF	11055051
LM MOTOR 230A SR PROPORTIONAL	11055052
LM MOTOR 24A SR PROPORTIONAL	11055053
LF MOTOR 24 SR PROPORTIONAL.	11055054
MOTOR LF230 ON/OFF	11055081
LF MOTOR 24 ON/OFF	11055082

Damper

11055118 RGE Ø450 Manual and Motorised with kit

Dimensional data

Variants	H (mm)	L (mm)	Ø (mm)	Weight (kg)
11055118	85	200	450	4,6

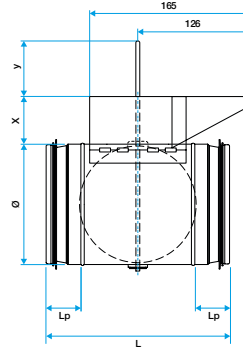

Regulatory data

Variants	Airtightness class	Upstream/downstream airtightness class
11055118	C	4

Installation

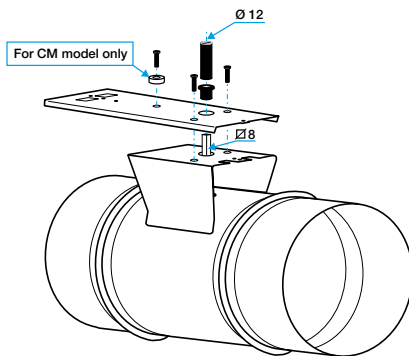

Installation de la platine de motorisation