

Balancing damper

11066533

RG0 GALVA - 425X130

The RG0 oblong balancing damper is used to adjust the pressure in oblong ducting branches in commercial or multi-occupancy residential buildings.



Oblong Balancing Damper

PRODUCT BENEFITS

- small size for high airflow,
- good airtight performance and controlled pressure losses,
- easy to install and maintain (no inaccessible corners).

Product description

The RG0 oblong balancing damper is used to adjust the pressure in oblong ducting branches in commercial or multi-occupancy residential buildings.

Fields of application

Multi-occupancy residential housing, New, Refurbishment, Non-residential buildings

Installation

- easy assembly of interlocking accessories: ducts are female, accessories are male,
- Final seal requires sealant and/or perforated strip,
- attached to duct using self-tapping screws (4 to 6 depending on diameter).

Reference arguments

Application:

- Oblong accessories for installation of ventilation systems in confined spaces (suspended ceiling, horizontal side flues conveying high airflow, etc.)
- Enables pressure control in branches of oblong ducting system.

Description:

- Oblong balancing damper made of galvanised steel.
- Length 425 mm and height 130 mm.

Main characteristics

- standard dimensions (20 oblong sections),
- galvanised steel as per EN 10346 ensuring uniformity of coating,
- M0 fire certification.

Dimensional data

References	H (mm)	L (mm)
11066533	130	425

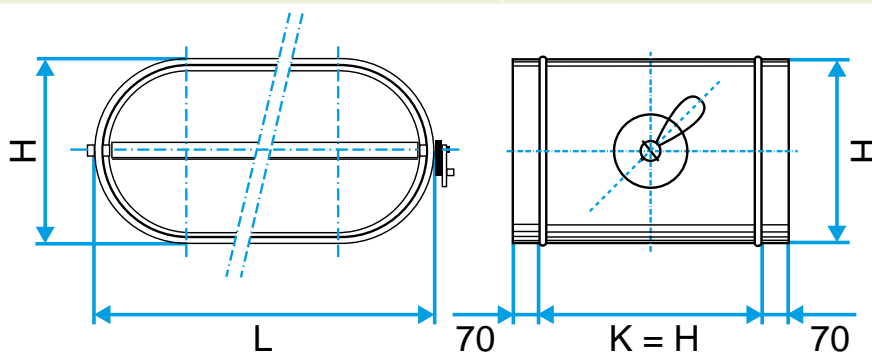

Dimensional drawing Oblong Balancing Damper

Balancing damper

11066533

RG0 GALVA - 425X130