

## Balancing damper

# 11063092

## RG0 GALVA - 850x265

The RG0 oblong balancing damper is used to adjust the pressure in oblong ducting branches in commercial or multi-occupancy residential buildings.



Oblong Balancing Damper

### PRODUCT BENEFITS

- small size for high airflow,
- good airtight performance and controlled pressure losses,
- easy to install and maintain (no inaccessible corners).

### Product description

The RG0 oblong balancing damper is used to adjust the pressure in oblong ducting branches in commercial or multi-occupancy residential buildings.

### Fields of application

Multi-occupancy residential housing, New, Refurbishment, Non-residential buildings

### Installation

- easy assembly of interlocking accessories: ducts are female, accessories are male,
- Final seal requires sealant and/or perforated strip,
- attached to duct using self-tapping screws (4 to 6 depending on diameter).

### Reference arguments

Application:

- Oblong accessories for installation of ventilation systems in confined spaces (suspended ceiling, horizontal side flues conveying high airflow, etc.)
- Enables pressure control in branches of oblong ducting system.

Description:

- Oblong balancing damper made of galvanised steel.
- Length 850 mm and height 265 mm.

### Main characteristics

- standard dimensions (20 oblong sections),
- galvanised steel as per EN 10346 ensuring uniformity of coating,
- M0 fire certification.

### Dimensional data

References	H (mm)	L (mm)
11063092	265	850

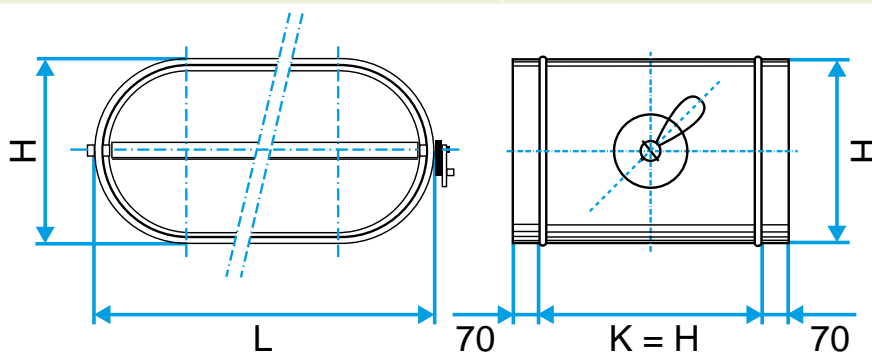

Dimensional drawing Oblong Balancing Damper

Balancing damper

11063092

RG0 GALVA - 850x265