

Balancing damper**11095820**
RGP ALU - D315

The aluminium balancing damper is used to adjust the pressure in aluminium ducting branches in commercial or multi-occupancy residential buildings.



Registre d'Equilibrage Perforé en aluminium

PRODUCT BENEFITS

- range compliant with gas CMEV requirements,
- suited to systems operating in saline atmospheres.

Product description

The aluminium balancing damper is used to adjust the pressure in aluminium ducting branches in commercial or multi-occupancy residential buildings. The RGP aluminium balancing damper enables finer pressure adjustment than a standard damper, as it avoids closing off a duct branch fully (especially in gas CMEV systems).

Fields of application

Multi-occupancy residential housing, New, Refurbishment, Non-residential buildings

Installation

- easy assembly of interlocking accessories: ducts are female, accessories are male,
- Final seal requires sealant and/or perforated strip,
- attached to duct using self-tapping screws (4 to 6 depending on diameter).

Reference arguments

Application:

- Serves to efficiently balance airflow across all branches of a multi-occupancy residential gas CMEV system
- Slotted damper used to prevent total closure of a duct branch

Description:

- Slotted aluminium damper diameter 315 mm
- Manual control
- Perforated diaphragm with 40% open surface, holes diameter 5 mm
- Screw-locked plastic handle, M1 class Lexan shafts

Main characteristics

- available in diameters from 125 to 315,
- aluminium 1050A-H18 (formerly A5) compliant with DTU 68.3 for gas CMEV,
- screw-locked plastic handle, M1 certified Lexan shafts,
- RGP: perforated disc with 40% air passage, Ø 5 holes,
- maximum operating temperature: + 120°C,
- M0 fire certification.

Balancing damper

11095820

RGP ALU - D315

Dimensional data

References	Ø (mm)
11095820	315

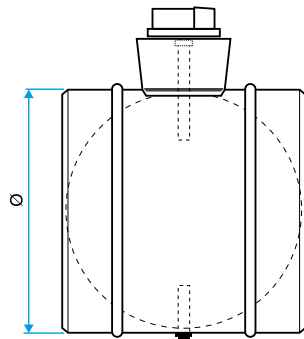

Encombrement Registres RG / RGP Alu