

Connector

11063015

RMO GALVA - 820x320

The RMO oblong male connector connects two galvanised oblong ducts together.



Oblong Male Connector

PRODUCT BENEFITS

- small size for high airflow,
- good airtight performance and controlled pressure losses,
- easy to install and maintain (no inaccessible corners).

Product description

The RMO oblong male connector connects two galvanised oblong ducts together.

Fields of application

Multi-occupancy residential housing, New, Refurbishment, Non-residential buildings

Installation

- easy assembly of interlocking accessories: ducts are female, accessories are male,
- Final seal requires sealant and/or perforated strip,
- attached to duct using self-tapping screws (4 to 6 depending on diameter).

Reference arguments

Application:

- Oblong accessories for installation of ventilation systems in confined spaces (suspended ceiling, horizontal side flues conveying high airflow, etc.)
- Connection between two oblong ducts of same dimensions

Description:

- Oblong male connector made of galvanised steel.
- Length 820 mm and height 320 mm.

Main characteristics

- standard dimensions (20 oblong sections),
- galvanised steel as per EN 10346 ensuring uniformity of coating,
- MO fire certification.

Dimensional data

References	H (mm)	L (mm)
11063015	320	820

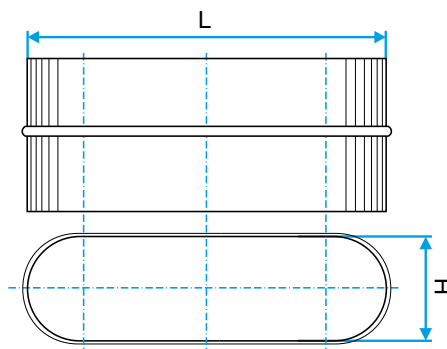

Dimensional drawing Male Oblong Connector

Connector

11063015

RMO GALVA - 820x320

Regulatory data

References	Fire protection rating
11063015	M0