

11030115

ROOF OUTLET D400 SLATE

The standard roof outlet was designed for CMEV and air handling systems in multi-occupancy residential and commercial buildings.



Standard roof outlet

Product description

The standard roof outlet was designed for CMEV and air handling systems in multi-occupancy housing and commercial buildings. It can be used as an air inlet or outlet, and also to evacuate kitchen hood fumes. The STS is available in 9 sizes from diameter 160 to 630 mm and comes in 2 different finishes (slate or tile). The STS standard roof outlet can be used on any type of roof, as it is made airtight with a lead kit.

Fields of application

Multi-occupancy residential housing, New, Refurbishment, Non-residential buildings

Installation

- the metal sleeve used to connect to the ventilation duct is attached to the support plate attached to the roof structure and to the formable lead sheet to make a seal (Ø 160: metal sleeve attached to lead sheet only):
 - Ø • 160: remove the rain hood held in place by 2 or 4 screws, Ø 160: remove the rain hood clipped onto the sleeve,
 - Ø • 160: fix the support plate on the roof structure using as many of the in-built holes as possible,
 - form the lead sheet to seal the fitting while avoiding the crimped edges,
 - Ø 160: for a tile roof, create a shim in the direction of the slats to support the lead sheet,
 - install the rain hood cover with the air outlet perpendicular to the slope of the roof,
 - Ø • 160: refit and securely fasten the 2 or 4 attachment screws and connect the metal sleeve to the ventilation duct.

Reference arguments

200

Main characteristics

- galvanised steel compliant with EN 10346 ensuring regularity of the coating.
- contents of STS:
 - rotating rain cowl fitted with a removable bird guard,
 - roofing support plate featuring four fastening strips,
 - duct connection shaft.
- 2 finishes available:
 - slate roof model: smooth anthracite grey paint finish (RAL 7024),
 - tile roof model: smooth brick finish (RAL 8012),

11030115

ROOF OUTLET D400 SLATE

Dimensional data

References	A (mm)	B (mm)	C (mm)	E (mm)	F (mm)	G (mm)	I (mm)	J (mm)	Ø D (mm)
11030115	200	550	660	160	900	750	600	750	400

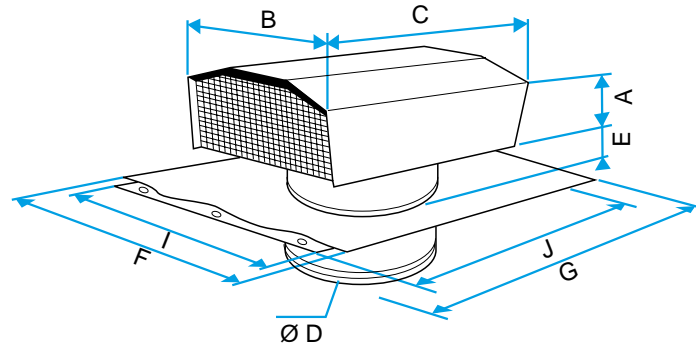

Dimensional drawing Standard roof outlet