

Connector

11064271

ROTP GALVA - 850x265 / 675x215

The ROTP oblong tangent reducer is used to connect oblong ducts of different diameters while maintaining a linear and flat ducting without losing space underneath.



Oblong Tangent Reducer on flat section:

PRODUCT BENEFITS

- small size for high airflow,
- good airtight performance and controlled pressure losses,
- easy to install and maintain (no inaccessible corners).

Product description

The ROCTP oblong tangent reducer on flat section is used to connect two oblong ducts of different diameters while maintaining a linear and flat ducting without losing space underneath.

Fields of application

Multi-occupancy residential housing, New, Refurbishment, Non-residential buildings

Installation

- easy assembly of interlocking accessories: ducts are female, accessories are male,
- Final seal requires sealant and/or perforated strip,
- attached to duct using self-tapping screws (4 to 6 depending on diameter).

Reference arguments

Application:

- Oblong accessories for installation of ventilation systems in confined spaces (suspended ceiling, horizontal side flues conveying high airflow, etc.)
- Tangential oblong-oblong reducer used to connect oblong ducting to oblong ducting of a different size while retaining a linear, flat system without losing space underneath
- If no reduction on height, use an RCO.

Description:

- ROTP tangential oblong reducer on flat section, galvanised steel
- Length 850 mm x height 265 mm - Length 675 mm x height 215 mm

Main characteristics

- standard dimensions (20 oblong sections),
- galvanised steel as per EN 10346 ensuring uniformity of coating,
- M0 fire certification.

Connector

11064271

ROTP GALVA - 850x265 / 675x215

Dimensional data

References	H (mm)	L (mm)
11064271	265	850

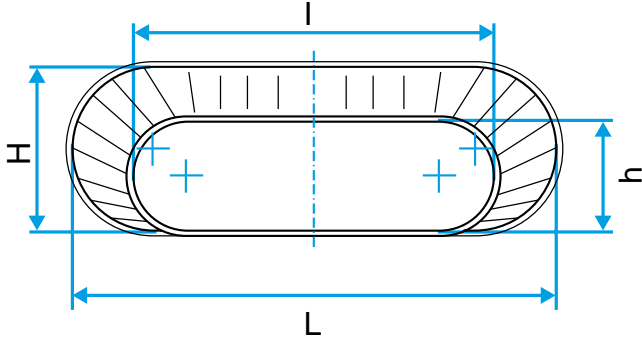

Dimensional drawing Oblong Tangent Reducer on flat section



Dimensional drawing Oblong Tangent Reducer on flat section



Regulatory data

References	Fire protection rating
11064271	M0