

Connector

11095472 RPC ALU - D400/315

The RPC aluminium joins two aluminium ducts of different diameters together over a minimum length.



Réduction Plate Concentrique en aluminium

PRODUCT BENEFITS

- range compliant with gas CMEV requirements,
- suited to systems operating in saline atmospheres.

Product description

The aluminium concentric flat reducer connects two aluminium ducts of different diameters together over a minimum length. For air supply purposes, prefer a conical reducer due to the pressure losses generated by the flat reducer.

Fields of application

Multi-occupancy residential housing, New, Refurbishment, Non-residential buildings

Installation

- easy assembly of interlocking accessories: ducts are female, accessories are male,
- Final seal requires sealant and/or perforated strip,
- attached to duct using self-tapping screws (4 to 6 depending on diameter).

Reference arguments

Application:

- Concentric flat reducer used to connect a duct diameter 400 mm to a duct diameter 315 mm over a minimum length on a Gas CMEV system
- Not for use on supply ducts, generates high pressure losses

Description:

- Concentric flat reducer aluminium diameter 400/315 mm

Main characteristics

- available in diameters from 125 to 500,
- aluminium 1050A-H18 (formerly A5) compliant with DTU 68.3 for gas CMEV,
- M0 fire certification.

Dimensional data

References	Ø A (mm)	Ø B (mm)
11095472	400	315

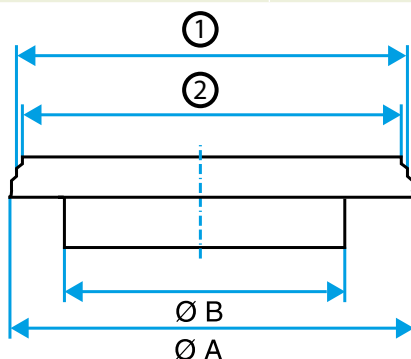

Dimensional drawing Aluminium Concentric Flat Reducer

Connector

11095472
RPC ALU - D400/315

Regulatory data

References	Fire protection rating
11095472	M0