

**Connector**

## 11093476 RPC REDUCER GALVA - D400/125

The RPC joins two galvanised ducts of different diameters together over a minimum length.



Réduction Plate Concentrique

**Product description**

The concentric flat reducer connects two galvanised ducts of different diameters together over a minimum length. For air supply purposes, prefer a conical reducer due to the pressure losses generated by the flat reducer.

**Fields of application**

Multi-occupancy residential housing, New, Refurbishment, Non-residential buildings

**Installation**

- easy assembly of interlocking accessories: ducts are female, accessories are male,
- Final seal requires sealant and/or perforated strip,
- attached to duct using self-tapping screws (4 to 6 depending on diameter).

**Reference arguments**

Application:

- Concentric flat reducer used to connect a duct diameter 400 mm to a duct diameter 125 mm over a minimum length
- Not for use on supply ducts, generates high pressure losses

Description:

- Concentric flat reducer galvanised steel diameter 400/125 mm

**Main characteristics**

- available in diameters from 80 to 630,
- galvanised steel as per EN 10346 ensuring uniformity of coating,
- MO fire certification.

**Dimensional data**

References	Ø A (mm)	Ø B (mm)
11093476	400	125

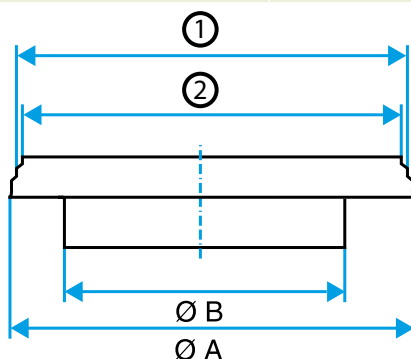

Dimensional drawing Concentric Flat Reducer

Connector

11093476

RPC REDUCER GALVA - D400/125

Regulatory data

References	Fire protection rating
11093476	M0