

Connector

11093938 RPC REDUCER GALVA - D560/125

The RPC joins two galvanised ducts of different diameters together over a minimum length.



Réduction Plate Concentrique

Product description

The concentric flat reducer connects two galvanised ducts of different diameters together over a minimum length. For air supply purposes, prefer a conical reducer due to the pressure losses generated by the flat reducer.

Fields of application

Multi-occupancy residential housing, New, Refurbishment, Non-residential buildings

Installation

- easy assembly of interlocking accessories: ducts are female, accessories are male,
- Final seal requires sealant and/or perforated strip,
- attached to duct using self-tapping screws (4 to 6 depending on diameter).

Reference arguments

Application:

- Concentric flat reducer used to connect a duct diameter 560 mm to a duct diameter 125 mm over a minimum length
- Not for use on supply ducts, generates high pressure losses

Description:

- Concentric flat reducer galvanised steel diameter 560/125 mm

Main characteristics

- available in diameters from 80 to 630,
- galvanised steel as per EN 10346 ensuring uniformity of coating,
- MO fire certification.

Dimensional data

References	Ø A (mm)	Ø B (mm)
11093938	560	125

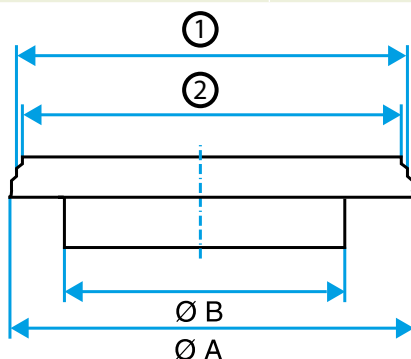

Dimensional drawing Concentric Flat Reducer

Connector

11093938
RPC REDUCER GALVA - D560/125

Regulatory data

References	Fire protection rating
11093938	M0