

**Connector**

## 11093937 RPC REDUCER GALVA - D560/160

The RPC joins two galvanised ducts of different diameters together over a minimum length.



Réduction Plate Concentrique

**Product description**

The concentric flat reducer connects two galvanised ducts of different diameters together over a minimum length. For air supply purposes, prefer a conical reducer due to the pressure losses generated by the flat reducer.

**Fields of application**

Multi-occupancy residential housing, New, Refurbishment, Non-residential buildings

**Installation**

- easy assembly of interlocking accessories: ducts are female, accessories are male,
- Final seal requires sealant and/or perforated strip,
- attached to duct using self-tapping screws (4 to 6 depending on diameter).

**Reference arguments**

Application:

- Concentric flat reducer used to connect a duct diameter 560 mm to a duct diameter 160 mm over a minimum length
- Not for use on supply ducts, generates high pressure losses

Description:

- Concentric flat reducer galvanised steel diameter 560/160 mm

**Main characteristics**

- available in diameters from 80 to 630,
- galvanised steel as per EN 10346 ensuring uniformity of coating,
- MO fire certification.

**Dimensional data**

References	Ø A (mm)	Ø B (mm)
11093937	560	160

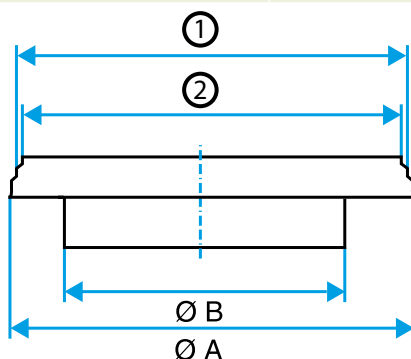

Dimensional drawing Concentric Flat Reducer

Connector

11093937

RPC REDUCER GALVA - D560/160

Regulatory data

References	Fire protection rating
11093937	M0