

Wall grille

11050063

SC102D F3 400X100

The SC 102 D steel wall grille enables air extraction on all ventilation and air-conditioning systems.



SC102D F3 400X100

PRODUCT BENEFITS

- adjustable vanes,
- easy to install / remove.

Principles of operation

The SC 102 D dual-deflection has individually dirigible horizontal and vertical vanes to adjust the air supply level in a room.

Product description

The SC 102 D is a steel dual deflection wall-mounted grille, white paint coating, with individually adjustable, movable horizontal rear and vertical front vanes.

Fields of application

New, Refurbishment, Non-residential buildings

Installation

- wall installation,
- concealed F3 attachment using friction clips.

Reference arguments

- AC 101 and SC 101 F3: single deflection terminal (exhaust) with vertical, individually adjustable vanes, pitch 20 mm.
- AC 102 D F3 and SC 102 D F3: double deflection grille (air supply) with movable, individually adjustable horizontal fins at rear, vertical at front, 20 mm pitch.
- AC models: anodised aluminium, natural satin finish.
- SC models: steel with epoxy paint finish, RAL 9010 white.
- Concealed attachment using friction clips.

Main characteristics

- Steel with white epoxy paint finish, RAL 9003 30% matt,
- horizontal fins at the rear and vertical fins at the front, individually adjustable, 20 mm pitch
- dimensions from 75 x 75 to 1200 x 600 mm with increments of 25 mm in length & height.

Accessories

Désignations	References
Adapter F4 400X100	11053764
PLEN. ME F3 400X100/D125 PC	11053665
MTF3 400X100/D125 PLENUM PA	11053635
RECT DAMPER SGS 400X100	11053244
ME Plenum F3 400X100/D125 PC cfg	11053582
MT Plenum F3 400X100/D125 PA cfg	11053438

General data

References	Type of finish	Colour
11050063	Epoxy paint	Lagoon blue

Wall grille

11050063
SC102D F3 400X100

Dimensional data

References	H (mm)	L (mm)
11050063	100	400

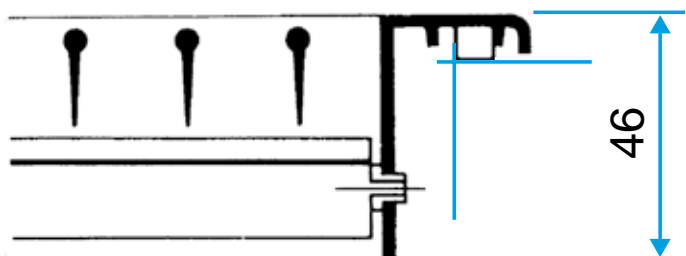

Grille SC 102 D seule

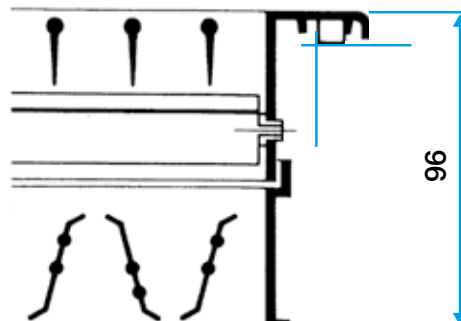

Grille SC 102 D avec registre AGB ou SGS monté

Airflow data

References	Comfort airflow for $L_w < NR 25$ (m ³ /h)
11050063	400