

Ceiling diffuser**11051140**
SC310R F16 D160 300x300

The SC 310 R is a square slotted opening diffuser, operating in up to 4 directions using adjustable deflectors.



SC310R F16 D160 300x300

PRODUCT BENEFITS

- circular connection for faster installation,
- up to four diffusion directions adjustable on site.

Principles of operation

The SC 310 R diffuser is installed on a plaster or BA13 ceiling. It diffuses air in up to 4 directions using adjustable deflectors. It opens to enable easy access for installation and maintenance.

Product description

The SC 310 R is a square slotted opening air supply diffuser, operating in up to 4 directions using individually adjustable deflectors. For installation in plaster and plasterboard ceilings. Diffuses air in HVAC systems. This diffuser is made of steel with epoxy coating RAL 9003 white 30% gloss. It features concealed attachments and is connected directly to circular ducting or using an NE plenum.

Fields of application

Non-residential buildings

Installation

The SC 310 R diffuser is installed flush with the ceiling. It can be connected directly to the ducting or using an NE plenum with a side branch connection, which will enable the air to expand and offer more homogeneous diffusion.

Reference arguments

- Removable slotted plate.
- Steel finish, epoxy paint RAL 9010 white.
- Concealed attachment to concrete slab using F16 brackets fitted to diffuser.
- Direct connection to circular duct.

Main characteristics

- SC 310R adjustable square slotted plate opening air supply diffuser,
- up to 4 diffusion directions using individually adjusted deflectors,
- steel with epoxy paint:
 - standard: RAL 9003 white 30% matt,
 - option: other RAL.
- concealed attachment to concrete slab using F16 brackets on diffuser,
- direct connection to circular duct,
- flush-mounted on ceiling,
- concealed attachment:
 - F0: screws in the side of the neck,
 - F16: with 3 brackets riveted to shell.
- connection to circular ducts,
- thermal insulation on outside of shell (optional).

Ceiling diffuser

11051140
SC310R F16 D160 300x300

Supplementary characteristics

- accessories:
 - BR damper,
 - galvanised steel plenum with side branch connection (NE).

Accessories

Désignations	References
BR CIRCULAR DAMPER D160	11053220

Dimensional data

References	C (mm)	F (mm)	H3 (mm)	L x H (mm)	W (mm)	Ø D (mm)
11051140	98	55	260	300X300	280	160

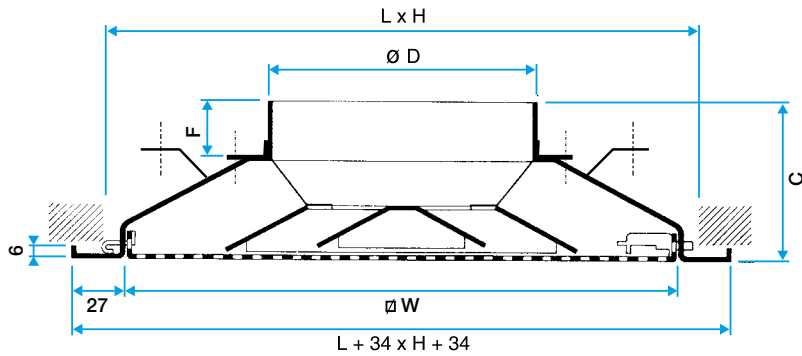

Diffuseur SC 310 R

Airflow data

References	Comfort airflow for Lw 40 dB(A) (extract with filter) (m³/h)	Comfort airflow for Lw 40 dB(A) (air supply) (m³/h)
11051140	250	250