

Ceiling diffuser

11002675

SF704 450x450

The SF 704 is a steel square ceiling diffuser with 4 air diffusion directions, for use in commercial buildings.



SF 704 diffuser

PRODUCT BENEFITS

- filter for return (optional),
- filter accessed by simply and quickly removing the central core,
- for 600 x 600 suspended ceiling tiles.

Principles of operation

The SF 704 diffuser is installed on the ceiling using visible or concealed attachments. The steel square diffuser offers 4 air diffusion directions.

Product description

The SF 704 is a steel square ceiling diffuser with 4 diffusion directions for ventilation or air-conditioning systems in commercial buildings. This diffuser is made of steel with epoxy coating RAL 9010 white 30% gloss. It is installed flush with the ceiling. Available in dimensions from 150x150 mm to 600x600 mm.

Fields of application

Non-residential buildings

Installation

The SF 704 diffuser is installed flush with the ceiling using visible or concealed attachments in the frame. A concealed screw and suspension bridge attachment system is also available and preferred for installation on fixed ceilings.

Main characteristics

- square ceiling diffuser,
- multi-direction horizontal air diffusion,
- 4 diffusion directions,
- profiled steel plate outer frame and core,
- removable, exchangeable core,
- frame width 32 mm,
- epoxy coating RAL 9010 white 30% gloss,
- installed flush with ceiling,
- available in dimensions from 150x150 mm to 600x600 mm.

Ceiling diffuser

11002675
SF704 450x450

Supplementary characteristics

- accessories:
 - B 700: counter-rotary damper, adjustable from front of diffuser,
 - W4 G3 pleated filter M1 fire certification for use on extraction,
 - galvanised steel connection plenum with RT or RE branch connection.

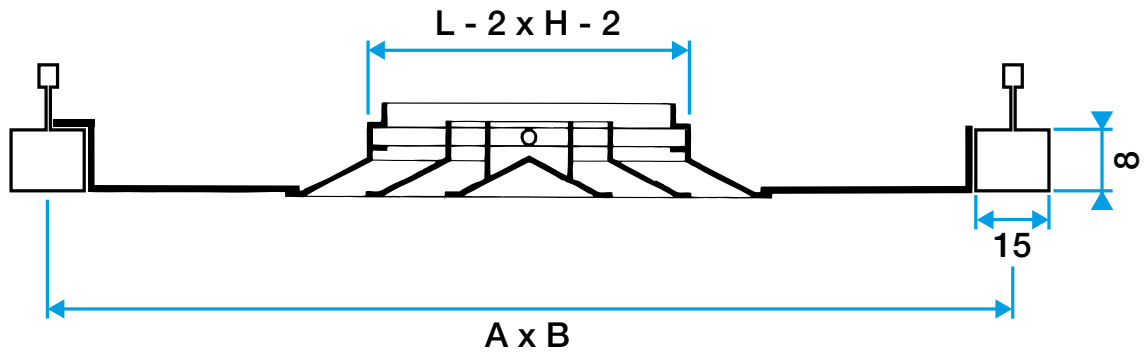

Diffuseur SF 704