

Ceiling diffuser

11002699

SF704TP 375x375 AxB=675x675

The SF 704 TP is a square ceiling diffuser for ceiling tiles with 4 air diffusion directions, for use in commercial buildings.



Diffuser SF 704TP

PRODUCT BENEFITS

- filter for return (optional),
- filter accessed by simply and quickly removing the central core,
- for 600 x 600 suspended ceiling tiles.

Principles of operation

The SF 704 TP diffuser is installed in a ceiling in place of a standard 600 x 600 mm or 675 x 675 mm ceiling tile. This steel square diffuser offers 4 air diffusion directions.

Product description

The SF 704 TP is a square ceiling diffuser with 4 diffusion directions for ventilation or air-conditioning systems in commercial buildings. This diffuser is made of steel with epoxy coating RAL 9010 white 30% gloss. It is installed flush with the ceiling in place of a standard 600 x 600 mm or 675 x 675 mm ceiling tile. It is suitable for "T-bar" or "Fine Line" suspended ceiling frames .

Fields of application

Non-residential buildings

Installation

The SF 704 TP diffuser is installed in place of a standard 600 x 600 mm or 675 x 675 mm ceiling tile.

Main characteristics

- square ceiling diffuser,
- multi-direction horizontal air diffusion,
- 4 diffusion directions,
- profiled steel plate outer frame and core,
- removable, exchangeable core,
- frame width 32 mm,
- epoxy coating RAL 9010 white 30% gloss,
- installed flush with ceiling in place of a standard 600 x 600 mm or 675 x 675 mm ceiling tile,
- suitable for "T-bar" or "Fine Line" suspended ceiling frames.

Ceiling diffuser

11002699

SF704TP 375x375 AxB=675x675

Supplementary characteristics

- accessories:
 - B 700: counter-rotary damper, adjustable from front of diffuser,
 - W4 G3 pleated filter M1 fire certification for use on extraction,
 - galvanised steel connection plenum with RT or RE branch connection.

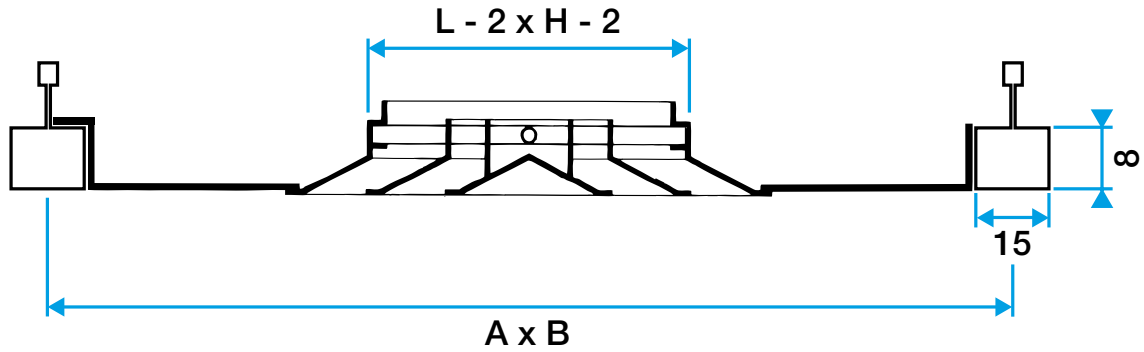

Diffuseur SF 704 TP