

11030133

STE 200-315 DECK/FLAT ROOF/SLATE

The aesthetic roof outlet was designed for CMEV and air handling systems in multi-occupancy residential and commercial buildings.



PRODUCT BENEFITS

- identical aesthetics to conventional chimneys,
- base unit and outlet are removable to ensure easy installation (except flat roof model),
- base unit body integrates duct attachment system.

Product description

The aesthetic roof outlet was designed for CMEV and air handling systems in multi-occupancy housing and commercial buildings. It can be used as an air inlet or outlet, and also to evacuate kitchen hood fumes. The STE is made of galvanised steel and available in 4 sizes up to diameter 630 mm (steel deck / flat roof / slate or tile) and available in 5 different colours.

Fields of application

Multi-occupancy residential housing, New, Refurbishment, Non-residential buildings

Installation

- dry installation on all types of roof:
 - airtight base frame made of extensible aluminium / elastomer for tile roofs,
 - airtight base frame made of galvanised steel for slate or flat roofs,
 - airtight base frame made of galvanised steel for steel tray roofs with cladding (model and dimensions of steel tray required).
- the base frame is movable to facilitate installation on site (except for monobloc flat roof model),
- attachment to roof structure using 4 screw-on brackets,
- adjustable fastening collar for ventilation duct to handle multiple diameters,
- To guarantee better airtight performance, use an RCC or RPC for 125, 200, 250, 355, 400, 450, 560 size ducts.

Main characteristics

- galvanised steel as per EN 10346 ensuring uniformity of coating,
- 5 paint colours available:
 - black,
 - amaranth,
 - brown,
 - chamois brown,
 - ochre.
- available in steel deck / flat roof / slate or tile versions.

Supplementary characteristics

- specify in order:
 - incline (% or °) and type of roof,
 - if steel deck: make + model of deck,
 - if tiles: colour of sealing kit,
 - other roofs,
 - finish (5 colours possible).

Options

base

11030133

STE 200-315 DECK/FLAT ROOF/SLATE

Dimensional data

References	Ø D MAX. (mm)	Ø D MIN. (mm)	Ø outlet (mm)	Section A (mm x mm)	Section B (mm)	Section C (mm)	Section D (mm)
11030133	315	200	315	370 x 370	200	240	35

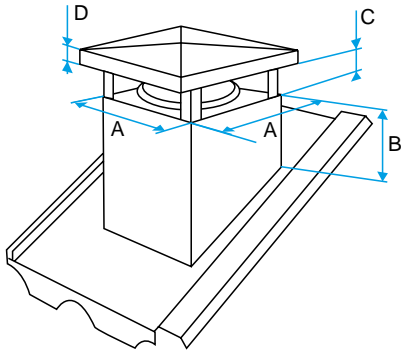

Schéma d'encombrement Sortie de Toit Esthétique

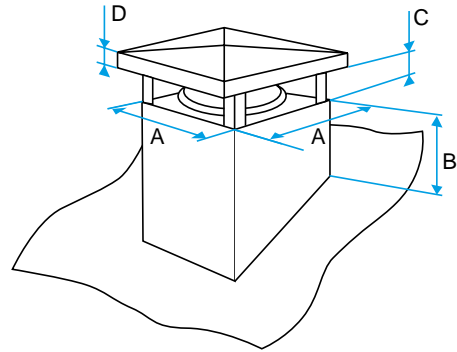

Schéma d'encombrement Sortie de Toit Esthétique