

Connector

11094780

Sealing flap Ø 250

The sealing flap is a galvanised steel ducting accessory that ensures a leaktight seal on roof penetrations.



Sealing flap

Product description

The sealing flap is a galvanised steel ducting accessory that ensures a leaktight seal on roof penetrations.

Fields of application

Multi-occupancy residential housing, New, Refurbishment, Non-residential buildings

Installation

- Two screws enable adaptation to male or female diameters.
- Final leak tightness ensured on site with sealant or silicone.

Reference arguments

Application:

- Sealing flap to ensure airtight roof penetration for ventilation ducting

Description:

- Galvanised steel sealing flap diameter 250 mm

Main characteristics

- range available from diameter 100 to 800.
- galvanised steel compliant with EN 10346 ensuring regularity of the coating.
- M0 fire rating.

Dimensional data

References	Ø (mm)
11094780	250

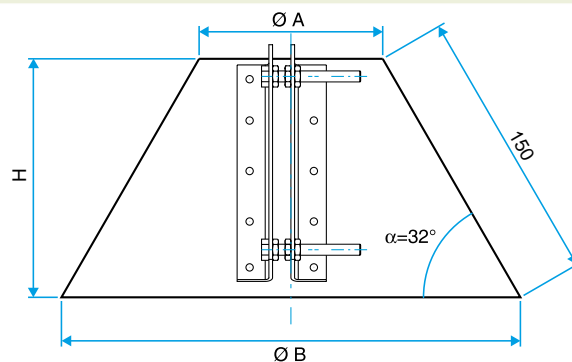

Encombrement Bavette d'étanchéité