

**Connector**

## 11094784 Sealing flap Ø 450

The sealing flap is a galvanised steel ducting accessory that ensures a leaktight seal on roof penetrations.



Sealing flap

**Product description**

The sealing flap is a galvanised steel ducting accessory that ensures a leaktight seal on roof penetrations.

**Fields of application**

Multi-occupancy residential housing, New, Refurbishment, Non-residential buildings

**Installation**

- Two screws enable adaptation to male or female diameters.
- Final leak tightness ensured on site with sealant or silicone.

**Reference arguments**

Application:

- Sealing flap to ensure airtight roof penetration for ventilation ducting

Description:

- Galvanised steel sealing flap diameter 450 mm

**Main characteristics**

- range available from diameter 100 to 800.
- galvanised steel compliant with EN 10346 ensuring regularity of the coating.
- M0 fire rating.

**Dimensional data**

References	Ø (mm)
11094784	450

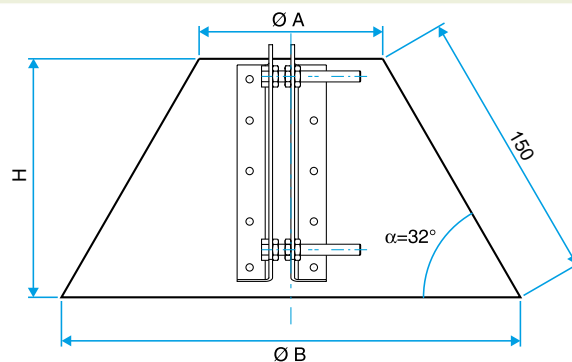

Encombrement Bavette d'étanchéité