

Connector**11094862**
T-PIECE FLAT 2A GALV-D200/355

The CPT2A branch connector provides a junction and accessibility to the vertical collector system and horizontal ducting, improves acoustic and aeraulic performance.

**PRODUCT BENEFITS**

- exclusive CPT2A (ALDES patent) - reduced fan consumption,
- 35% less pressure loss compared to a standard CPT,
- improved noise attenuation: 7 dB(A) on noise radiated from the fan (3 dB(A) better than a standard CPT connector).

Produktbeskrivelse

The T-piece acoustic and aeraulic branch connector for air tightness readings (CPT) is a galvanised steel accessory used to join the vertical collector system and horizontal ducting while enabling accessibility to the vertical riser and horizontal ducting as per the requirements of DTU 68.1 and 68.2. It is specifically designed for risers opening out into attics or flat roofs of commercial and multi-occupancy residential buildings, for which the airtight reading is made after the T-piece is installed. The CP2A T-piece acoustic and aeraulic branch connector is fitted with a stop ring on the unit body to hold the plug in a stable position and limit the risk of leaks. The aeraulic properties of the CPT2A T-piece branch connector reduce the negative pressure required for the fan and enable the use of less powerful fans, which generate less noise and consume less energy.

Fields of application

Multi-occupancy residential housing, New, Refurbishment, Non-residential buildings

Installation

- easy assembly of interlocking accessories: ducts are female, accessories are male,
- final seal requires sealant and/or perforated strip,
- attached to duct using self-tapping screws (4 to 6 depending on diameter),
- installation requires a flat roof penetration sleeve: FT.

Reference arguments

Application:

- Flat roof T-piece connector or T-piece connector 200/355 mm
- Specifically designed for risers opening out into attics or flat roofs, for which the airtight reading is made after the T-piece is installed
- 2A (Acoustic-Aeraulic) version: - 35% less pressure loss - fan noise attenuation approx -7dB(A)

Description:

- T-piece branch connector galvanised steel diameter 200/355 mm
- B-s1, d0 acoustic foam with high sound attenuation
- Sheet metal deflector offering tool-free removal
- A stop-ring on the body maintains the plug in a stable position and limits the risk of leaks
- Small size facilitates installation

Main characteristics

- range available from diameter 125 to 500.
- $\emptyset B - \emptyset A \geq 100$ mm enabling an airtight overlap on a flat roof.
- performance of CPT2A compared to standard CPT connector:
 - acoustic: acoustic foam B-s1, d0 offering high attenuation of fan noise (by 7 dB(A), or 3 dB(A) better than a standard CPT),
 - aeraulic: sheet metal deflector offering tool-free removal, reducing pressure losses by 35% or -7 Pa at 4 m/s.
- galvanised steel compliant with EN 10346 ensuring regularity of the coating.
- material compliant with requirements of DTU 68.3: 2013-06 P1-1: "Mechanical Ventilation Installations",
- M0 fire certification.

Connector

11094862 T-PIECE FLAT 2A GALV-D200/355

General data

Variants	Main material
11094862	Galvanised steel

Dimensional data

Variants	L (mm)	Ø A (mm)	Ø B (mm)	Weight (kg)
11094862	350	200	355	4,0

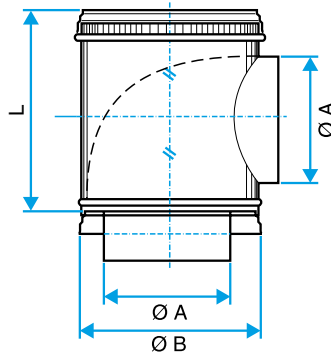

Regulatory data

Variants	Fire protection rating
11094862	M0

Installation



Installation du déflecteur acoustique et aéraulique dans le caisson piquage



Installation du déflecteur acoustique et aéraulique dans le caisson piquage