

Connector**11098020****TE GALVA Branch piece+seal - Ø 355/355 mm**

The right-angle T-piece with seal is used to connected two galvanised ducts at a 90° angle while delivering class C airtight performance.



Right-angle T-piece + seal

PRODUCT BENEFITS

- easy and quick to install,
- class C airtight performance,
- aesthetic ducting.

Product description

The right-angle T-piece with seal is used to connected two galvanised ducts at a 90° angle while delivering class C airtight performance. It ensures leak-free installation without excessive pressure losses on the branch connection.

Fields of application

Multi-occupancy residential housing, New, Refurbishment, Non-residential buildings

Installation

- to slot in or remove an accessory, rotate it slightly in the duct,
- as an airtight seal is automatically provided by the ALDES seal, no need to use sealant or adhesive tape,
- for vertical installations especially, the use of self-tapping screws remains recommended,
- time savings in relation to ducting with standard accessories is in the range of 20 % (at least 15 to 30 seconds saved per junction for diameters 125 to 315, or at least 30 to 60 seconds saved for each accessory in these diameters),
- ALDES sealed accessories are specially designed to ensure easy connection / disconnection. The ALDES range offers class C airtight performance and low connection torque.

Reference arguments

Application:

- Used for airtight connection between two ducting branches at an angle of 90° on non-residential and multi-occupancy residential systems.

Description:

- Sealed T-piece galvanised steel diameter 355/355 mm

Main characteristics

- available in diameters from 125 to 560,
- galvanised steel as per EN 10346 ensuring uniformity of coating,
- crimped seal up to and including diameter 315,
- dual-hardness seal in groove for diameters above 315,
- temperature range: - 30°C à + 100°C,
- resistant to ageing (• 30 years), UV and ozone,
- MO fire certification,
- class C airtight performance as per standard NF EN 12237.

Connector

11098020

TE GALVA Branch piece+seal - Ø 355/355 mm

Dimensional data

References	Ø A (mm)	Ø B (mm)
11098020	355	355

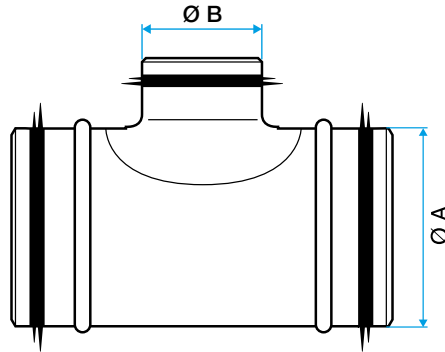

Dimensional drawing sealed T-piece

Regulatory data

References	Fire protection rating
11098020	M0