

**Connector****11094176**  
**TE GALVA T-PIECE - D560/250**

The TE 90° T-piece is used to connect two ductwork branches at an angle of 90°.



Té Equerre 90°

**Product description**

The TE 90° T-piece is used to connect two ductwork branches at an angle of 90°. It ensures leak-free installation without excessive pressure losses on the branch connection.

**Fields of application**

Multi-occupancy residential housing, New, Refurbishment, Non-residential buildings

**Installation**

- easy assembly of interlocking accessories: ducts are female, accessories are male,
- Final seal requires sealant and/or perforated strip,
- attached to duct using self-tapping screws (4 to 6 depending on diameter).

**Reference arguments**

Application:

- Connects two ducting branches at an angle of 90° on non-residential and multi-occupancy residential systems

Description:

- TE T-piece galvanised steel diameter 560/250 mm

**Main characteristics**

- available in diameters from 80 to 900,
- galvanised steel as per EN 10346 ensuring uniformity of coating,
- MO fire certification.

**Dimensional data**

References	Ø A (mm)	Ø B (mm)
11094176	560	250

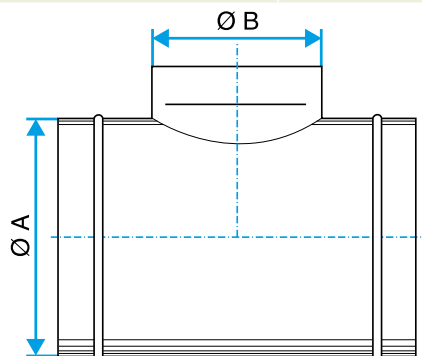

Dimensional drawing 90° T-piece

Connector

11094176

TE GALVA T-PIECE - D560/250

Regulatory data

References	Fire protection rating
11094176	M0