

Connector**11094001**
TE GALVA T-PIECE - D560/560

The TE 90° T-piece is used to connect two ductwork branches at an angle of 90°.



Té Equerre 90°

Product description

The TE 90° T-piece is used to connect two ductwork branches at an angle of 90°. It ensures leak-free installation without excessive pressure losses on the branch connection.

Fields of application

Multi-occupancy residential housing, New, Refurbishment, Non-residential buildings

Installation

- easy assembly of interlocking accessories: ducts are female, accessories are male,
- Final seal requires sealant and/or perforated strip,
- attached to duct using self-tapping screws (4 to 6 depending on diameter).

Reference arguments

Application:

- Connects two ducting branches at an angle of 90° on non-residential and multi-occupancy residential systems

Description:

- TE T-piece galvanised steel diameter 560/560 mm

Main characteristics

- available in diameters from 80 to 900,
- galvanised steel as per EN 10346 ensuring uniformity of coating,
- MO fire certification.

Dimensional data

References	Ø A (mm)	Ø B (mm)
11094001	560	560

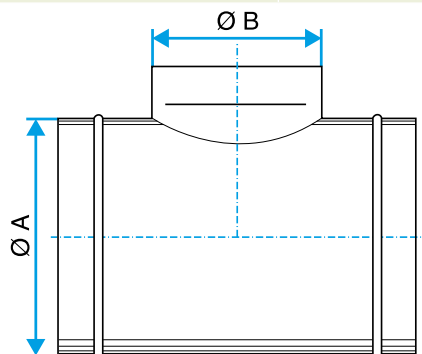

Dimensional drawing 90° T-piece

Connector

11094001

TE GALVA T-PIECE - D560/560

Regulatory data

References	Fire protection rating
11094001	M0