

Connector

11095198

TE T-PIECE ALU D450/315

The TE 90° Alu T-piece is used to connect two aluminium ductwork branches at an angle of 90°.



PRODUCT BENEFITS

- range compliant with gas CMEV requirements,
- suited to systems operating in saline atmospheres.

Product description

The TE 90° aluminium T-piece is used to connect two aluminium ductwork branches at an angle of 90°. It ensures leak-free installation without excessive pressure losses at the junction.

Fields of application

Multi-occupancy residential housing, New, Refurbishment, Non-residential buildings

Installation

- easy assembly of interlocking accessories: ducts are female, accessories are male,
- Final seal requires sealant and/or perforated strip,
- attached to duct using self-tapping screws (4 to 6 depending on diameter).

Reference arguments

Application:

- Connects two ducting branches at an angle of 90° on multi-occupancy residential gas CMEV system

Description:

- T-piece aluminium diameter 450/315 mm

Main characteristics

- available in diameters from 125 to 500,
- aluminium 1050A-H18 (formerly A5) compliant with DTU 68.3 for gas CMEV,
- MO fire certification.

Dimensional data

Variants	Ø A (mm)	Ø B (mm)
11095198	450	315

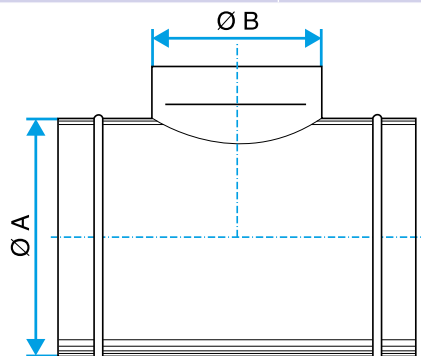

Regulatory data

Variants	Fire protection rating
11095198	MO

Connector

11095198

TE T-PIECE ALU D450/315