

## Connector

# 11095195

## TE T-PIECE ALU D450/450

The TE 90° Alu T-piece is used to connect two aluminium ductwork branches at an angle of 90°.



Té Equerre 90° en aluminium

### PRODUCT BENEFITS

- range compliant with gas CMEV requirements,
- suited to systems operating in saline atmospheres.

### Product description

The TE 90° aluminium T-piece is used to connect two aluminium ductwork branches at an angle of 90°. It ensures leak-free installation without excessive pressure losses at the junction.

### Fields of application

Multi-occupancy residential housing, New, Refurbishment, Non-residential buildings

### Installation

- easy assembly of interlocking accessories: ducts are female, accessories are male,
- Final seal requires sealant and/or perforated strip,
- attached to duct using self-tapping screws (4 to 6 depending on diameter).

### Reference arguments

Application:

- Connects two ducting branches at an angle of 90° on multi-occupancy residential gas CMEV system

Description:

- T-piece aluminium diameter 450/450 mm

### Main characteristics

- available in diameters from 125 to 500,
- aluminium 1050A-H18 (formerly A5) compliant with DTU 68.3 for gas CMEV,
- MO fire certification.

### Dimensional data

References	Ø A (mm)	Ø B (mm)
11095195	450	450



Schéma d'encombrement Té Equerre 90° en aluminium

## Connector

# 11095195

## TE T-PIECE ALU D450/450

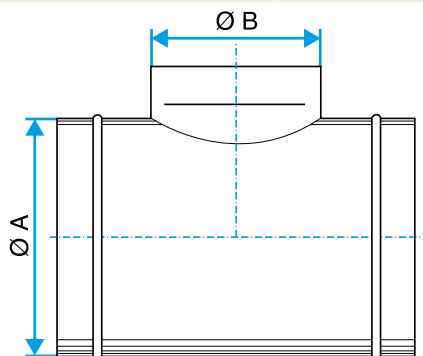
## Regulatory data

References	Fire protection rating
11095195	M0