

Connector

11093247 TO GALVA ANGLE T-PIECE D400/160

The TE 45° T-piece is used to connect two ductwork branches at an angle of 45°.



Té Oblique 45°

Product description

The TE 45° T-piece is used to connect two ductwork branches at an angle of 45°. Use a TO instead of a TE for an air supply duct. It ensures leak-free installation without excessive pressure losses on the branch connection.

Fields of application

Multi-occupancy residential housing, New, Refurbishment, Non-residential buildings

Installation

- easy assembly of interlocking accessories: ducts are female, accessories are male,
- Final seal requires sealant and/or perforated strip,
- attached to duct using self-tapping screws (4 to 6 depending on diameter).

Reference arguments

Application:

- Connects two ducting branches at an angle of 45° on non-residential and multi-occupancy residential systems
- Especially efficient for air supply compared to a 90° T-piece

Description:

- Angled T-piece galvanised steel diameter 400/160 mm

Main characteristics

- available in diameters from 80 to 900,
- galvanised steel as per EN 10346 ensuring uniformity of coating,
- MO fire certification.

Dimensional data

References	Ø A (mm)	Ø B (mm)
11093247	400	160

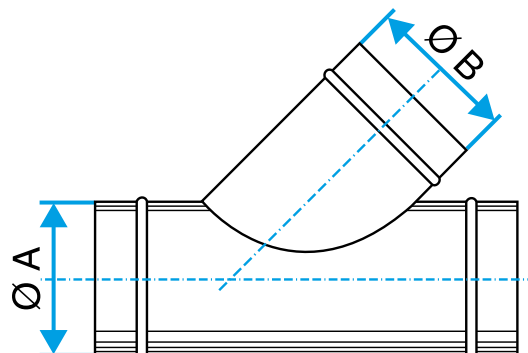

Dimensional drawing 45° Branch piece

Connector

11093247

TO GALVA ANGLE T-PIECE D400/160

Regulatory data

References	Fire protection rating
11093247	M0